

Description

The 74LVC1G06Q is an automotive-compliant, single inverter with an open-drain output. The device is designed for operation with a power supply range of 1.65V to 5.5V. The inputs are tolerant to 5.5V allowing this device to be used in a mixed-voltage environment. The device is fully specified for partial power down applications using I_{OFF}. The I_{OFF} circuitry disables the output preventing damaging current backflow when the device is powered down. The open-drain output can be connected to other open drain outputs to implement active-low wired-OR or active-high wired-AND functions. The maximum sink current is 32mA at 5V.

Pin Assignments

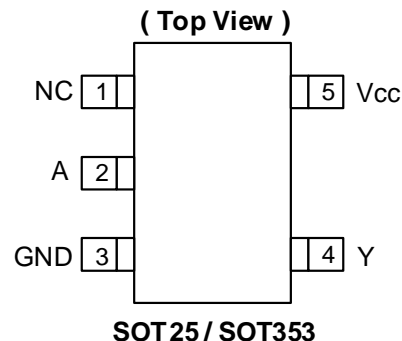

Features

- Grade 1 Ambient Temperature Operation: -40°C to +125°C
- Wide Supply Voltage Range from 1.65V to 5.5V
- 24mA Sink Current at 3.3V
- CMOS Low Power Consumption
- I_{OFF} Supports Partial-Power-Down Mode Operation
- Inputs Accept up to 5.5V Regardless of V_{CC} Level
- ESD Protection Tested per AEC-Q100
- Exceeds 2000V Human Body Model (AEC-Q100-002)
- Exceeds 1000V Charged Device Model (AEC-Q100-011)
- Latch-Up Exceeds 100mA (AEC-Q100-004)
- **Totally Lead-Free & Fully RoHS Compliant (Notes 1 & 2)**
- **Halogen and Antimony Free. "Green" Device (Note 3)**
- **The 74LVC1G06Q is suitable for automotive applications requiring specific change control; this part is AEC-Q100 qualified, PPAP capable, and manufactured in IATF 16949 certified facilities.**

<https://www.diodes.com/quality/product-definitions/>

Applications

- Voltage Level Shifting
- General Purpose Logic
- Power Down Signal Isolation
- Wide Array of Products such as:
 - Automotive Applications within Grade 1 Temperature Range
 - Industrial Computing/Controls/Automation
 - High Reliability Networking/Communications
 - Industrial/Agricultural Equipment

- Notes:
1. No purposely added lead. Fully EU Directive 2002/95/EC (RoHS), 2011/65/EU (RoHS 2) & 2015/863/EU (RoHS 3) compliant.
 2. See <https://www.diodes.com/quality/lead-free/> for more information about Diodes Incorporated's definitions of Halogen- and Antimony-free, "Green" and Lead-free.
 3. Halogen- and Antimony-free "Green" products are defined as those which contain <900ppm bromine, <900ppm chlorine (<1500ppm total Br + Cl) and <1000ppm antimony compounds.

Pin Descriptions

Pin Name	Description
NC	No Connection
A	Data Input
GND	Ground
Y	Data Output
V _{CC}	Supply Voltage

Logic Diagram

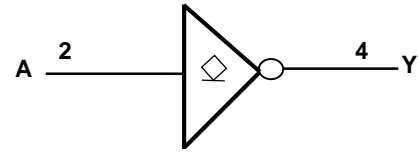

Function Table

Input	Output
A	Y
H	L
L	Z

Absolute Maximum Ratings (Notes 4 & 5)

Symbol	Description	Rating	Unit
ESD HBM	Human Body Model ESD Protection	2	kV
ESD CDM	Charged Device Model ESD Protection	1	kV
V _{CC}	Supply Voltage Range	-0.5 to 6.5	V
V _I	Input Voltage Range	-0.5 to 6.5	V
V _O	Voltage Applied to Output in High Impedance or I _{OFF} State	-0.5 to 6.5	V
V _O	Voltage Applied to Output in High or Low State	-0.5 to 6.5	V
I _{IK}	Input Clamp Current V _I < 0	-50	mA
I _{OK}	Output Clamp Current	-50	mA
I _O	Continuous Output Current	50	mA
I _{CC} , I _{GND}	Continuous Current Through V _{CC} or GND	±100	mA
T _J	Operating Junction Temperature	-40 to +150	°C
T _{STG}	Storage Temperature	-65 to +150	°C

- Notes:
- Stresses beyond the absolute maximum can result in immediate failure or reduced reliability. These are stress values and device operation should be within recommend values.
 - Forcing the maximum allowed voltage could cause a condition exceeding the maximum current or conversely forcing the maximum current could cause a condition exceeding the maximum voltage. The ratings of both current and voltage must be maintained within the controlled range.

Recommended Operating Conditions (Note 6)

Symbol	Parameter	Min	Max	Unit	
V _{CC}	Operating Voltage	Operating	1.65	5.5	V
		Data Retention Only	1.5	—	V
V _{IH}	High-Level Input Voltage	V _{CC} = 1.65V to 1.95V	0.65 × V _{CC}	—	V
		V _{CC} = 2.3V to 2.7V	1.7	—	
		V _{CC} = 3V to 3.6V	2	—	
		V _{CC} = 4.5V to 5.5V	0.7 × V _{CC}	—	
V _{IL}	Low-Level Input Voltage	V _{CC} = 1.65V to 1.95V	—	0.35 × V _{CC}	V
		V _{CC} = 2.3V to 2.7V	—	0.7	
		V _{CC} = 3V to 3.6V	—	0.8	
		V _{CC} = 4.5V to 5.5V	—	0.3 × V _{CC}	
V _I	Input Voltage	0	5.5	V	
V _O	Output Voltage	0	5.5	V	
I _{OL}	Low-Level Output Current	V _{CC} = 1.65V	—	4	mA
		V _{CC} = 2.3V	—	8	
		V _{CC} = 2.7V	—	12	
		V _{CC} = 3V	—	16	
		V _{CC} = 4.5V	—	24	
Δt/ΔV	Input Transition Rise or Fall Rate	V _{CC} = 1.8V ± 0.15V, 2.5V ± 0.2V	—	20	ns/V
		V _{CC} = 3.3V ± 0.3V	—	10	
		V _{CC} = 5V ± 0.5V	—	5	
T _A	Operating Free-Air Temperature	—	-40	+125	°C

Note: 6. Unused inputs should be held at V_{CC} or Ground.

Electrical Characteristics (All typical values are at $V_{CC} = 3.3V$, $T_A = +25^\circ C$.)

Symbol	Parameter	Test Conditions	Vcc	-40°C to +125°C			Unit	
				Min	Typ	Max		
V _{OL}	Low Level Output Voltage	V _I = V _{IH}	I _{OL} = 100µA	1.65V to 5.5V	—	—	0.1	V
			I _{OL} = 4mA	1.65V	—	—	0.45	
			I _{OL} = 8mA	2.3V	—	—	0.3	
			I _{OL} = 12mA	2.7V	—	—	0.4	
			I _{OL} = 24mA	3V	—	—	0.55	
			I _{OL} = 32mA	4.5V	—	—	0.55	
I _I	Input Current	V _I = 5.5V or GND	0 to 5.5V	—	±0.1	±1	µA	
I _{OFF}	Power Down Leakage Current	V _I or V _O = 5.5V	0V	—	—	±2	µA	
I _{OZ}	Z-State Leakage Current	V _I = V _{IL} , V _O = 5.5V	1.65V or 5.5V	—	±0.1	±2	µA	
I _{CC}	Supply Current	V _I = 5.5V or GND, I _O = 0	5.5V	—	0.1	4	µA	
ΔI _{CC}	Additional Supply Current	Input at V _{CC} – 0.6V	3V to 5.5V	—	—	500	µA	
C _I	Input Capacitance	V _I = V _{CC} to GND	3.3V	—	5.0	—	pF	

Package Characteristics

Symbol	Parameter	Package	Test Conditions	Min	Typ	Max	Unit
θ _{JA}	Thermal Resistance Junction-to-Ambient	SOT25	Note 7	—	184	—	°C/W
		SOT353		—	385	—	
θ _{JC}	Thermal Resistance Junction-to-Case	SOT25	Note 7	—	62	—	°C/W
		SOT353		—	164	—	

Note: 7. Device mounted on FR-4 substrate PC board, 2oz copper, with minimum recommended pad layout.

Switching Characteristics

Figure 1 Typical Values at $T_A = +25^\circ C$ and nominal voltages 1.8V, 2.5V, 2.7V, 3.3V, and 5.0V.

Parameter	From Input	To Output	Vcc	T _A = -40°C to +125°C			Unit
				Min	Typ	Max	
t _{PD}	A	Y	1.8V ± 0.15V	1.0	3.0	8.5	ns
			2.5V ± 0.2V	0.5	1.9	5.5	
			2.7V	0.5	2.5	6.0	
			3.3V ± 0.3V	0.5	2.3	5.5	
			5.0V ± 0.5V	0.5	1.7	4.0	

Operating Characteristics

T_A = +25°C

Parameter	Test Conditions	Vcc = 1.8V	Vcc = 2.5V	Vcc = 3.3V	Vcc = 5V	Unit	
		Typ	Typ	Typ	Typ		
C _{PD}	Power Dissipation Capacitance	f = 10MHz	3	3	4	6	pF

Measurement Information

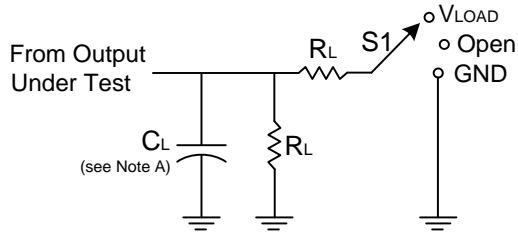

TEST	S1	CLRL
t_{PLZ}/t_{PZL}	V_{LOAD}	Per Table

V_{CC}	Inputs		V_M	V_{LOAD}	C_L	R_L	V_{Δ}
	V_I	t_R/t_F					
$1.8V \pm 0.15V$	V_{CC}	$\leq 2ns$	$V_{CC}/2$	$2 \times V_{CC}$	30pF	1k Ω	0.15V
$2.5V \pm 0.2V$	V_{CC}	$\leq 2ns$	$V_{CC}/2$	$2 \times V_{CC}$	30pF	500 Ω	0.15V
2.7V	2.7V	$\leq 2.5ns$	1.5V	6V	50pF	500 Ω	0.3V
$3.3V \pm 0.3V$	3V	$\leq 2.5ns$	1.5V	6V	50pF	500 Ω	0.3V
$5V \pm 0.5V$	V_{CC}	$\leq 2.5ns$	$V_{CC}/2$	$2 \times V_{CC}$	50pF	500 Ω	0.3V

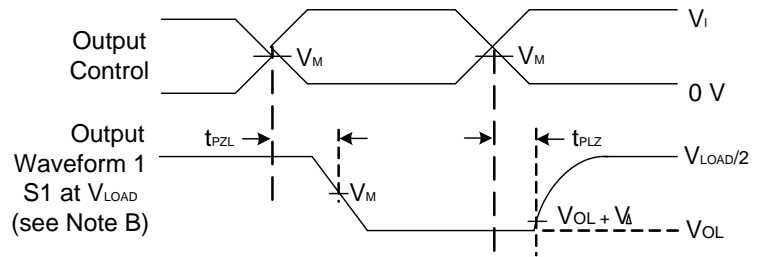
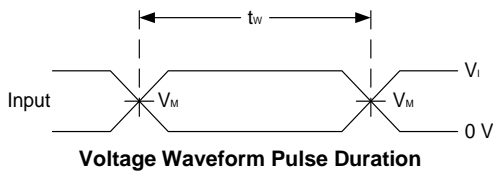

Voltage Waveform Enable and Disable Times Low and High Level Enabling

Figure 1. Load Circuit and Voltage Waveforms

- Notes:
- A. Includes test lead and test apparatus capacitance.
 - B. All pulses are supplied at pulse repetition rate $\leq 10MHz$.
 - C. The input is one transition per measurement.
 - D. For the open drain device t_{PLZ} and t_{PZL} are the same as t_{PD} .
 - E. t_{PZL} is measured at V_M .
 - F. t_{PLZ} is measured at $V_{OL} + V_{\Delta}$.

Ordering Information (Note 8)

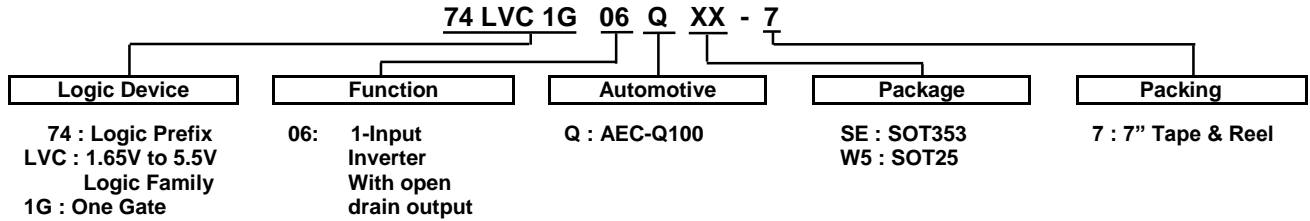

Part Number	Package Code	Package (Notes 9 & 10)	Package Size	7" Tape and Reel	
				Quantity	Part Number Suffix
74LVC1G06QSE-7	SE	SOT353	2.15mm × 2.1mm × 1.1mm 0.65mm lead pitch	3000/Tape & Reel	-7
74LVC1G06QW5-7	W5	SOT25	3.0mm × 2.8mm × 1.2mm 0.95mm lead pitch	3000/Tape & Reel	-7

Notes: 8. For packaging details, go to our website at <https://www.diodes.com/design/support/packaging/diodes-packaging/>.
 9. Pad layout as shown in Diodes Incorporated's package outline PDFs, which can be found on our website at <http://www.diodes.com/package-outlines.html>.
 10. The taping orientation is located on our website at <https://www.diodes.com/assets/Packaging-Support-Docs/ap02007.pdf>.

Marking Information

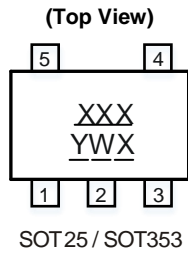

XXX : Identification Code
Y : Year 0~9
W : Week: A~Z 1~26 week
 a~z 27~52 week
 z represents week 52 and 53
X : A~ Z: Internal Code

Part Number	Package	Identification Code
74LVC1G06QW5-7	SOT25	UMQ
74LVC1G06QSE-7	SOT353	UMQ

Package Outline Dimensions

Please see <http://www.diodes.com/package-outlines.html> for the latest version.

(1) Package Type: SOT25



SOT25			
Dim	Min	Max	Typ
A	0.35	0.50	0.38
B	1.50	1.70	1.60
C	2.70	3.00	2.80
D	-	-	0.95
H	2.90	3.10	3.00
J	0.013	0.10	0.05
K	1.00	1.30	1.10
L	0.35	0.55	0.40
M	0.10	0.20	0.15
N	0.70	0.80	0.75
α	0°	8°	-
All Dimensions in mm			

(2) Package Type: SOT353

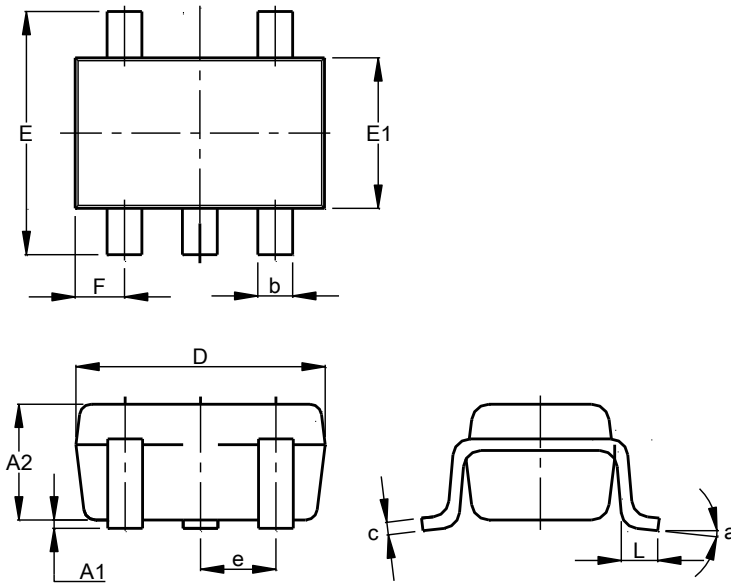

SOT353			
Dim	Min	Max	Typ
A1	0.00	0.10	0.05
A2	0.90	1.00	0.95
b	0.10	0.30	0.25
c	0.10	0.22	0.11
D	1.80	2.20	2.15
E	2.00	2.20	2.10
E1	1.15	1.35	1.30
e	0.650 BSC		
F	0.40	0.45	0.425
L	0.25	0.40	0.30
a	0°	8°	--
All Dimensions in mm			

Suggested Pad Layout

Please see <http://www.diodes.com/package-outlines.html> for the latest version.

(1) Package Type: SOT25

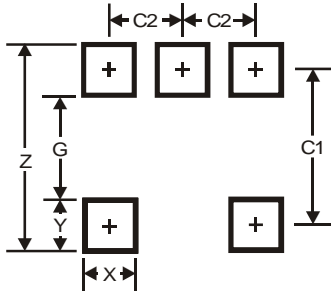

Dimensions	Value
Z	3.20
G	1.60
X	0.55
Y	0.80
C1	2.40
C2	0.95

(2) Package Type: SOT353



Dimensions	Value (in mm)
C	0.650
C1	1.900
G	1.300
X	0.420
X1	1.720
Y	0.600
Y1	2.500

Mechanical Data

SOT25

- Moisture Sensitivity: Level 1 per J-STD-020
- Terminals: Finish – Matte Tin Plated Leads, Solderable per MIL-STD-202, Method 208@3
- Weight: 0.0158 grams (Approximate)

SOT353

- Moisture Sensitivity: Level 1 per J-STD-020
- Terminals: Finish – Matte Tin Plated Leads, Solderable per MIL-STD-202, Method 208@3
- Weight: 0.0064 grams (Approximate)

IMPORTANT NOTICE

DIODES INCORPORATED MAKES NO WARRANTY OF ANY KIND, EXPRESS OR IMPLIED, WITH REGARDS TO THIS DOCUMENT, INCLUDING, BUT NOT LIMITED TO, THE IMPLIED WARRANTIES OF MERCHANTABILITY AND FITNESS FOR A PARTICULAR PURPOSE (AND THEIR EQUIVALENTS UNDER THE LAWS OF ANY JURISDICTION).

Diodes Incorporated and its subsidiaries reserve the right to make modifications, enhancements, improvements, corrections or other changes without further notice to this document and any product described herein. Diodes Incorporated does not assume any liability arising out of the application or use of this document or any product described herein; neither does Diodes Incorporated convey any license under its patent or trademark rights, nor the rights of others. Any Customer or user of this document or products described herein in such applications shall assume all risks of such use and will agree to hold Diodes Incorporated and all the companies whose products are represented on Diodes Incorporated website, harmless against all damages.

Diodes Incorporated does not warrant or accept any liability whatsoever in respect of any products purchased through unauthorized sales channel. Should Customers purchase or use Diodes Incorporated products for any unintended or unauthorized application, Customers shall indemnify and hold Diodes Incorporated and its representatives harmless against all claims, damages, expenses, and attorney fees arising out of, directly or indirectly, any claim of personal injury or death associated with such unintended or unauthorized application.

Products described herein may be covered by one or more United States, international or foreign patents pending. Product names and markings noted herein may also be covered by one or more United States, international or foreign trademarks.

This document is written in English but may be translated into multiple languages for reference. Only the English version of this document is the final and determinative format released by Diodes Incorporated.

LIFE SUPPORT

Diodes Incorporated products are specifically not authorized for use as critical components in life support devices or systems without the express written approval of the Chief Executive Officer of Diodes Incorporated. As used herein:

A. Life support devices or systems are devices or systems which:

1. are intended to implant into the body, or
2. support or sustain life and whose failure to perform when properly used in accordance with instructions for use provided in the labeling can be reasonably expected to result in significant injury to the user.

B. A critical component is any component in a life support device or system whose failure to perform can be reasonably expected to cause the failure of the life support device or to affect its safety or effectiveness.

Customers represent that they have all necessary expertise in the safety and regulatory ramifications of their life support devices or systems, and acknowledge and agree that they are solely responsible for all legal, regulatory and safety-related requirements concerning their products and any use of Diodes Incorporated products in such safety-critical, life support devices or systems, notwithstanding any devices- or systems-related information or support that may be provided by Diodes Incorporated. Further, Customers must fully indemnify Diodes Incorporated and its representatives against any damages arising out of the use of Diodes Incorporated products in such safety-critical, life support devices or systems.

Copyright © 2020, Diodes Incorporated

www.diodes.com